



# **OSNOVNE ELEKTRONSKE KOMPONENTE**

## **Podela prema načinu montaže:**

- za štampane ploče sa otvorima za priključke
- za SMD štampane ploče

## **Osnovna podela prema vrsti komponente:**

- pasivne
- aktivne

# OSNOVNE ELEKTRONSKE KOMPONENTE

**PASIVNE**

**OTPORNICI**

- Fiksni
  - ugljeni
  - metalslojni
  - žičani
- Promenljivi
- Za poseb. namene

**KONDENZATORI**

- Fiksni
  - keramički
  - film
  - liskunski
  - papirni
  - elektrolitski
- Promenljivi

**INDUKTIVNOSTI**

- Fiksne
  - sa jezgrom
  - bez jezgra
- Promenljive

**AKTIVNE**

**DIODE**

**TRANZISTORI**

**INTEGRISANA  
KOLA**

# OTPORNICI

TIP OTPORNIKA	OPSEG OTPORNOSTI	SNAGA	RADNI OPSEG TEMPERATURA	TEMPERATURNI KOEFICIJENT
ŽIČANI PRECIZNI	$0,1\Omega \div 1,2M\Omega$	$1/8 \div 1/4$ [W]	$-55 \div 145$ [°C]	10 ppm/°C
ŽIČANI SNAŽNI	$0,1\Omega \div 180k\Omega$	$1 \div 210$ [W]	$-55 \div 275$ [°C]	260 ppm/°C
METAL-FILM PRECIZNI	$1\Omega \div 250M\Omega$	$1/20 \div 1$ [W]	$-55 \div 125$ [°C]	$50 \div 100$ ppm/°C
METAL-FILM SNAŽNI	$5\Omega \div 100k\Omega$	$1 \div 5$ [W]	$-55 \div 155$ [°C]	$20 \div 100$ ppm/°C
UGLJENI	$2,7\Omega \div 100M\Omega$	$1/8 \div 2$ [W]	$-55 \div 130$ [°C]	1500 ppm/°C

## TIPIČNE KARAKTERISTIKE FIKSNIH OTPORNIKA

# SMD otpornici



Code		Length (l)		Width (w)		Height (h)		Power
Imperial	Metric	inch	mm	inch	mm	inch	mm	Watt
0201	0603	0.024	0.6	0.012	0.3	0.01	0.25	1/20 (0.05)
0402	1005	0.04	1.0	0.02	0.5	0.014	0.35	1/16 (0.062)
0603	1608	0.06	1.55	0.03	0.85	0.018	0.45	1/10 (0.10)
0805	2012	0.08	2.0	0.05	1.2	0.018	0.45	1/8 (0.125)
1206	3216	0.12	3.2	0.06	1.6	0.022	0.55	1/4 (0.25)
1210	3225	0.12	3.2	0.10	2.5	0.022	0.55	1/2 (0.50)
1218	3246	0.12	3.2	0.18	4.6	0.022	0.55	1
2010	5025	0.20	5.0	0.10	2.5	0.024	0.6	3/4 (0.75)
2512	6332	0.25	6.3	0.12	3.2	0.024	0.6	1

# Aksijalni otpornici

- Nije strogo standardizovano



Power rating	Body length (l)	Body diameter (d)	Lead length (a)	Lead diameter (da)
Watt	mm	mm	mm	mm
1/8 (0.125)	$3.0 \pm 0.3$	$1.8 \pm 0.3$	$28 \pm 3$	$0.45 \pm 0.05$
1/4 (0.25)	$6.5 \pm 0.5$	$2.5 \pm 0.3$	$28 \pm 3$	$0.6 \pm 0.05$
1/2 (0.5)	$8.5 \pm 0.5$	$3.2 \pm 0.3$	$28 \pm 3$	$0.6 \pm 0.05$
1	$11 \pm 1$	$5 \pm 0.5$	$28 \pm 3$	$0.8 \pm 0.05$

# MELF otpornici

- Podvrsta SMD-a, bolja stabilnost i niži temp. koeficijent



Name	Abbr.	Code	Length	Diameter	Power
			mm	mm	Watt
MicroMELF	MMU	0102	2.2	1.1	0.2 - 0.3
MiniMELF	MMA	0204	3.6	1.4	0.25 - 0.4
MELF	MMB	0207	5.8	2.2	0.4 - 1.0

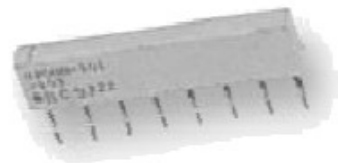
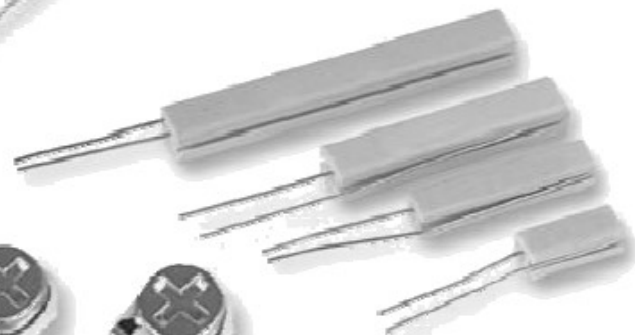

- Kelvinova veza – koristi se za merenje napona na malim impedansama, kako otpornosti žica ne bi uticale na merenja

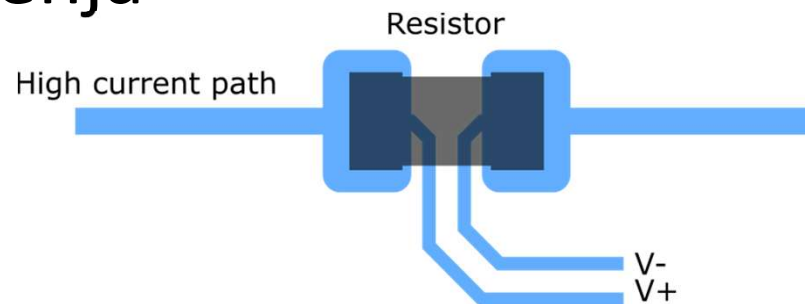

- Neki otpornici imaju već posebne priključke

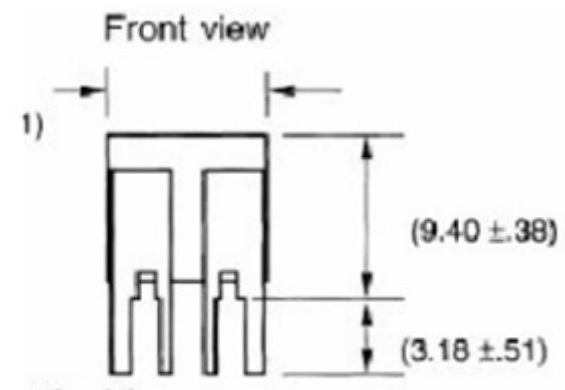



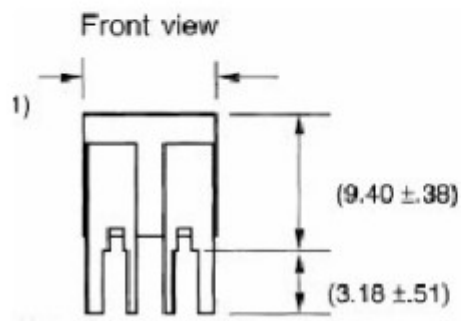
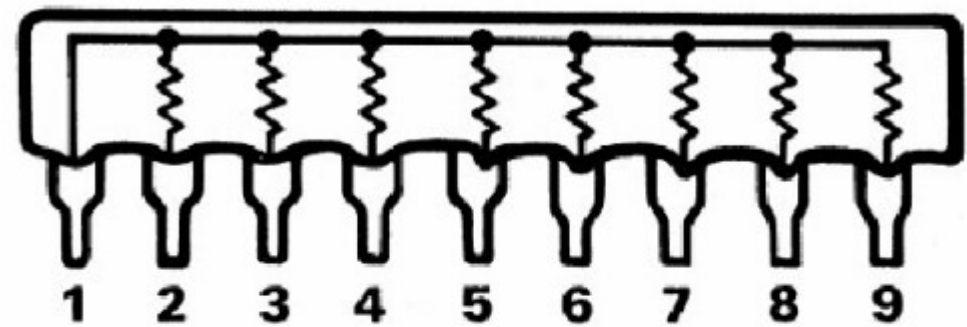
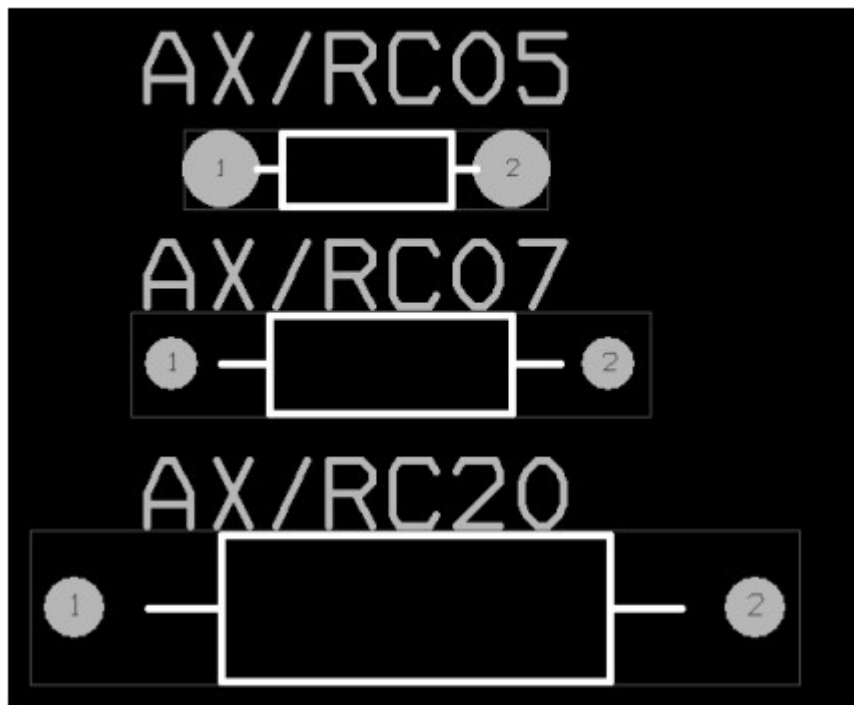

8 Isolated Resistors

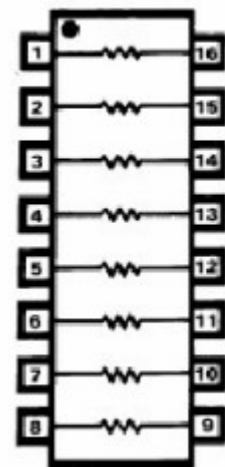

15 Bussed Resistors

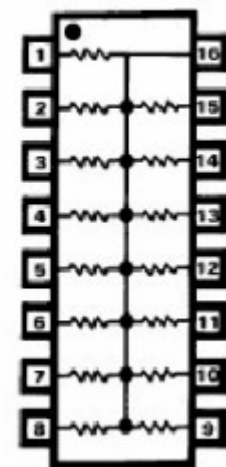

Top View

## TFx13 series, 0.1% TC25

- High long-term stability
- Low temperature coefficient
- Applications include motherboards, printers, telecom.

### technical specification

Size	1206	0803	0603
Power rating at 70°C	0.125W	0.125W	0.1W
Resistance Tolerance	0.1%		
Temperature Coefficient	±25ppm/°C		
Operating Temperature	-55°C to +125°C		
Max. Operating Voltage	200V	150V	75V

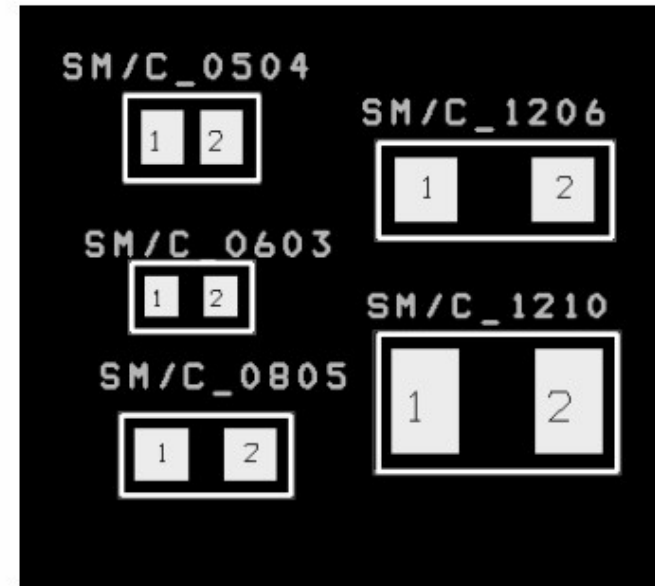

## 0.1% Precision Chip Resistor, 1206 Format, 10Ω to 1MΩ

**Phicomp**  
A YAGEO COMPANY

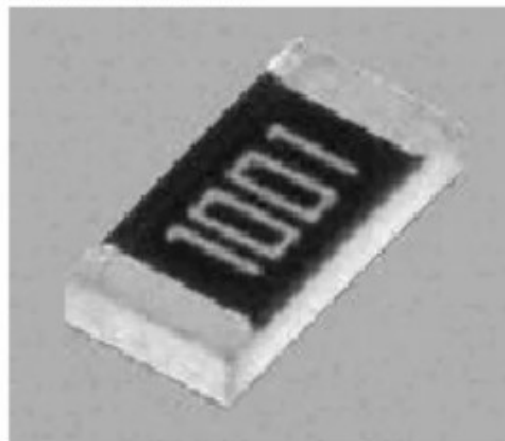

**Standardne vrednosti otpornosti ili kapacitivnosti u dekadi ← IEC 60063**

**Standardom su određeni nizovi vrednosti u dekadi.**

***En* niz ima *n* vrednosti.**

**Vrednosti u nizu *En* rastu približno (zaokruženo) sa faktorom  $10^{1/n}$**

**Otpornici tačnosti  $\pm 10\%$  koriste niz E12**

**Otpornici tačnosti  $\pm 2\%$  i  $\pm 5\%$  koriste niz E24**

**Otpornici tačnosti  $\pm 1\%$  koriste niz E96**

**Otpornici tačnosti  $\pm 0,1\%$ ,  $\pm 0,25\%$  i  $\pm 0,5\%$  koriste niz E192**

<b>E3-E192</b>																
According to IEC 60063																
E192	E96	E48	E192	E96	E48	E192	E96	E48	E192	E96	E48		E24	E12	E6	E3
100	100	100	178	178	178	316	316	316	562	562	562		10	10	10	10
101			180			320			569				11			
102	102		182	182		324	324		576	576			12	12		
104			184			328			583				13			
105	105	105	187	187	187	332	332	332	590	590	590		15	15	15	
106			189			336			597				16			
107	107		191	191		340	340		604	604			18	18		
109			193			344			612				20			
110	110	110	196	196	196	348	348	348	619	619	619		22	22	22	22
111			198			352			626				24			
113	113		200	200		357	357		634	634			27	27		
114			203			361			642				30			
115	115	115	205	205	205	365	365	365	649	649	649		33	33	33	
117			208			370			657				36			
118	118		210	210		374	374		665	665			39	39		
120			213			379			673				43			
121	121	121	215	215	215	383	383	383	681	681	681		47	47	47	47
123			218			388			690				51			
124	124		221	221		392	392		698	698			56	56		
126			223			397			706				62			
127	127	127	226	226	226	402	402	402	715	715	715		68	68	68	
129			229			407			723				75			
130	130		232	232		412	412		732	732			82	82		
132			234			417			741				91			
133	133	133	237	237	237	422	422	422	750	750	750					
135			240			427			759							
137	137		243	243		432	432		768	768						
138			246			437			777							
140	140	140	249	249	249	442	442	442	787	787	787					
142			252			448			796							
143	143		255	255		453	453		806	806						
145			258			459			816							
147	147	147	261	261	261	464	464	464	825	825	825					
149			264			470			835							
150	150		267	267		475	475		845	845						
152			271			481			856							
154	154	154	274	274	274	487	487	487	866	866	866					
156			277			493			876							
158	158		280	280		499	499		887	887						
160			284			505			898							
162	162	162	287	287	287	511	511	511	909	909	909					
164			291			517			920							
165	165		294	294		523	523		931	931						
167			298			530			942							
169	169	169	301	301	301	536	536	536	953	953	953					
172			305			542			965							
174	174		309	309		549	549		976	976						
176			312			556			988							

# Označavanje otpornosti prstenovima u boji (color code)

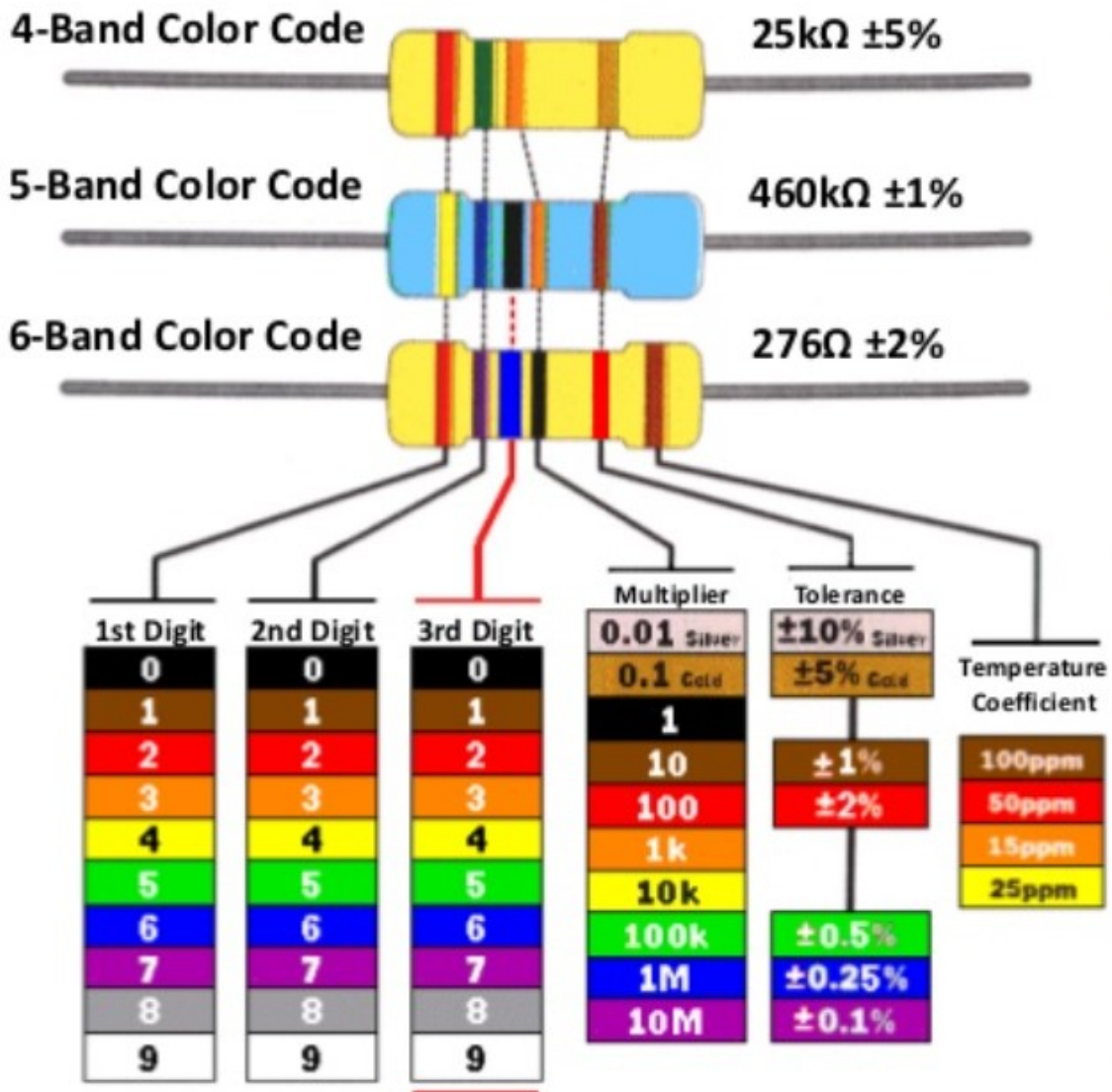

## Ultra High Precision Resistors

- TCR 0.2 ppm/°C (-55 to +125 °C)
- Tolerances to ± 0.001%
- Load-life stability to ±0.005%
- Power coef.: to 5 ppm at rated power
- Applications include military, medical, aerospace, high precision instrumentation and audio

## PRECIZNI OTPORNICI



Leaded and  
SMD available

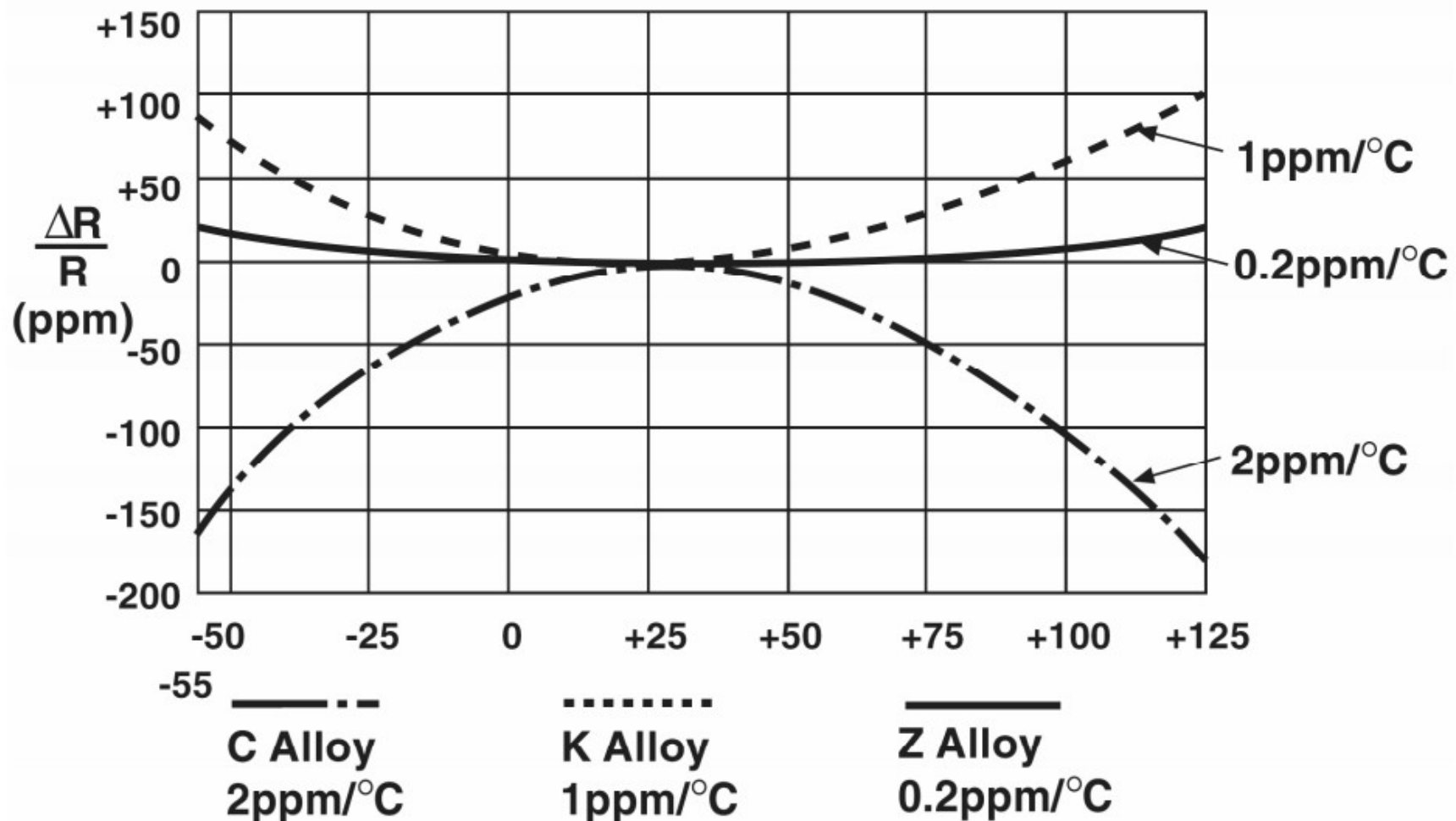

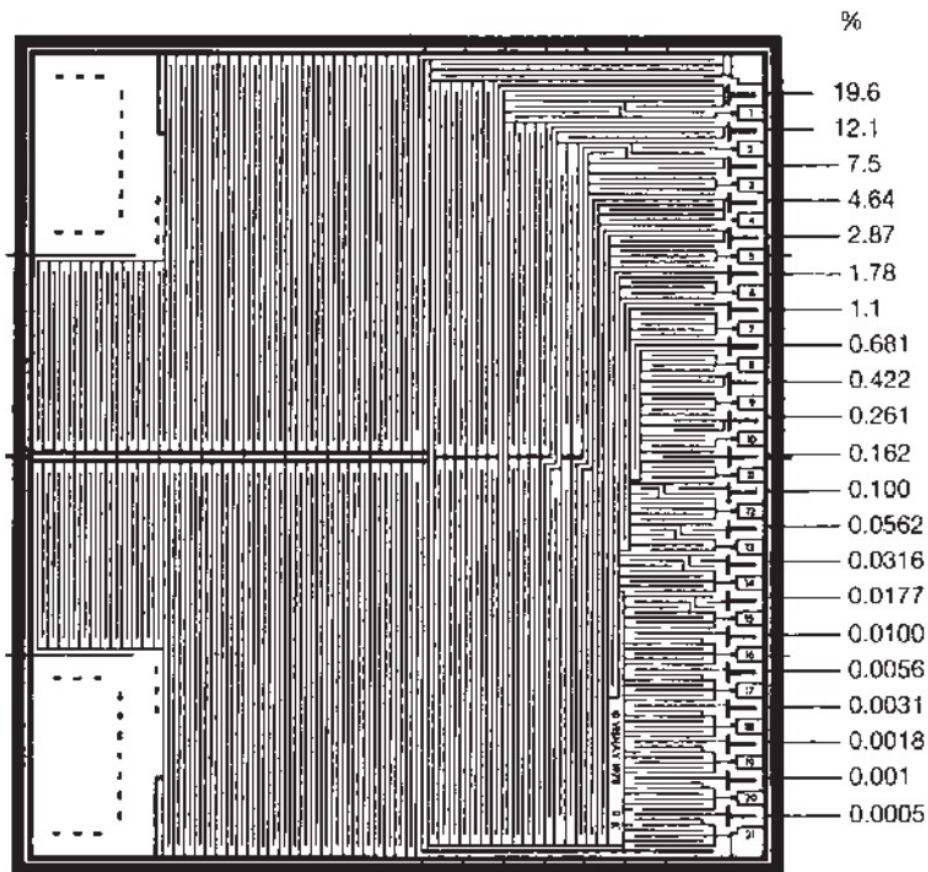

**NOTE:** Foil shown in white, etched spaces in black.

Interloop  
capacitance  
reduction  
in series

Mutual  
inductance  
reduction  
due to change  
in current  
direction

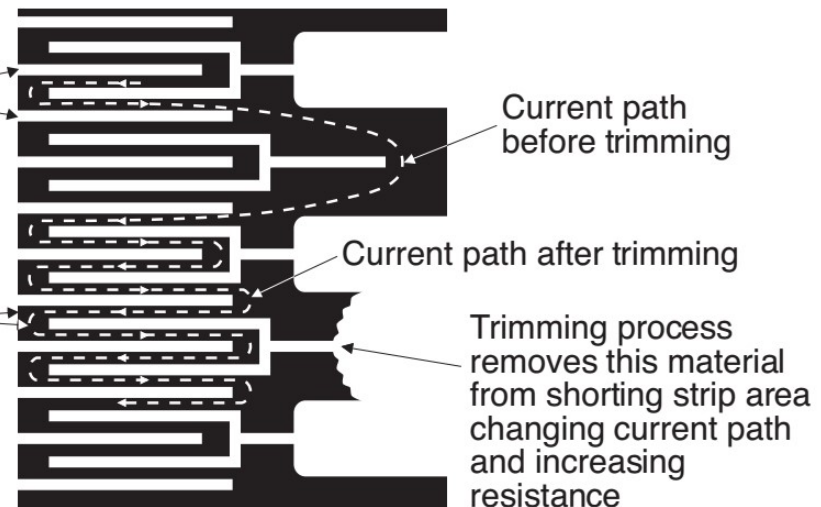

Foil shown in black, etched spaces in white

# Označavanje SMD otpornosti

- MELF prstenovima

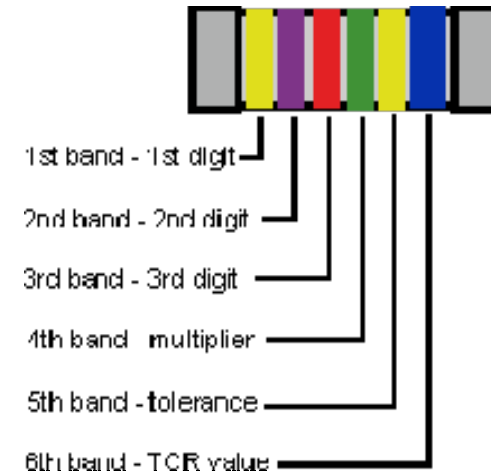

- Obični samo cifre, poslednja je eksponent
  - 1% tolerancija: XYZE  $\rightarrow (100 * X + 10 * Y + Z) * 10^E$
  - 5% tolerancija: XYE  $\rightarrow (10 * X + Y) * 10^E$ 
    - 4991  $\rightarrow 499 * 10 = 4.99 \text{ k}\Omega$
    - 513  $\rightarrow 51 * 1000 = 51 \text{ k}\Omega$





# Potenciometri

- Trimeri – retko podešavanje



- „Pravi“ potenciometri - češće korišćenje

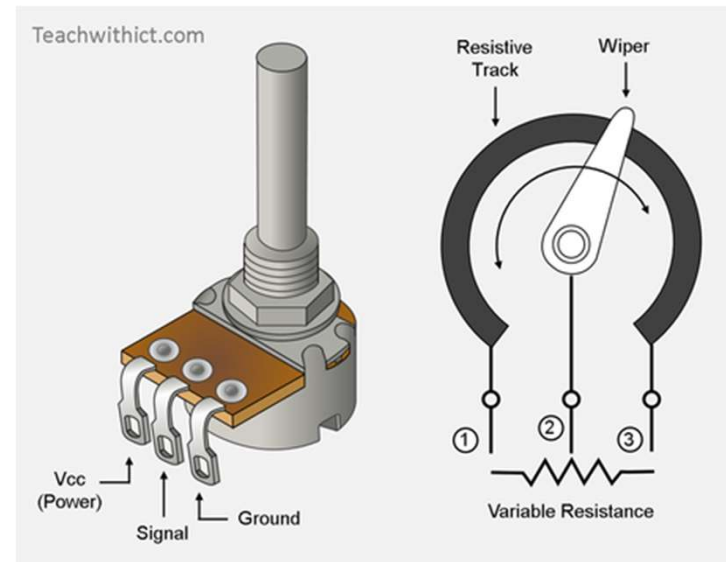

# KONDENZATORI

## Fiksni

- film
- keramički
- liskunski
- papirni
- elektrolitski

## Promenljivi

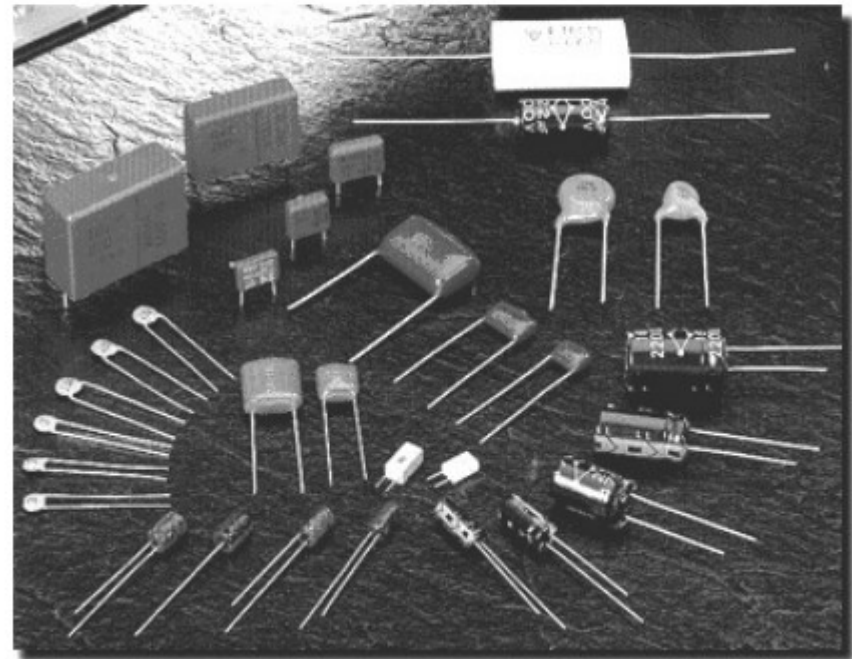

# FILM KONDENZATORI

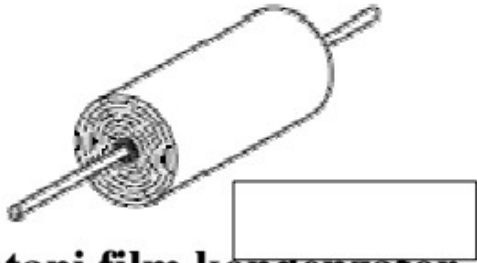

**Namotani film kondenzator  
(klasična tehnologija)**

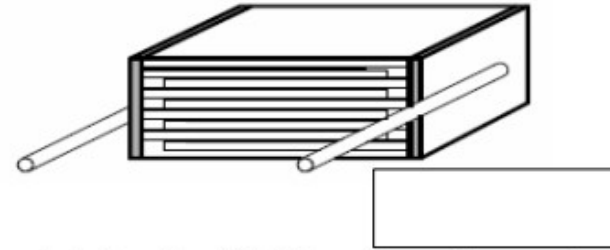

**Naslagani (stacked) film kondenzator  
(prednost u impulsnim primenama)**

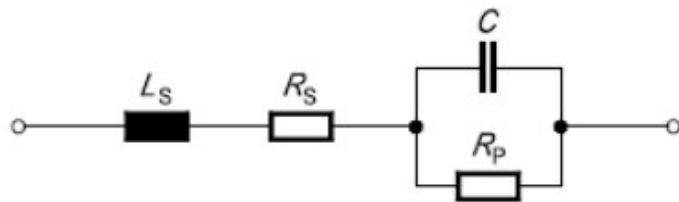

**Ekvivalentni model realnog  
kondenzatora**

$$f_{rez} = \frac{1}{2\pi\sqrt{CL_s}}$$

**Tipične krive impedanse film  
kondenzatora u funkciji učestanosti** →

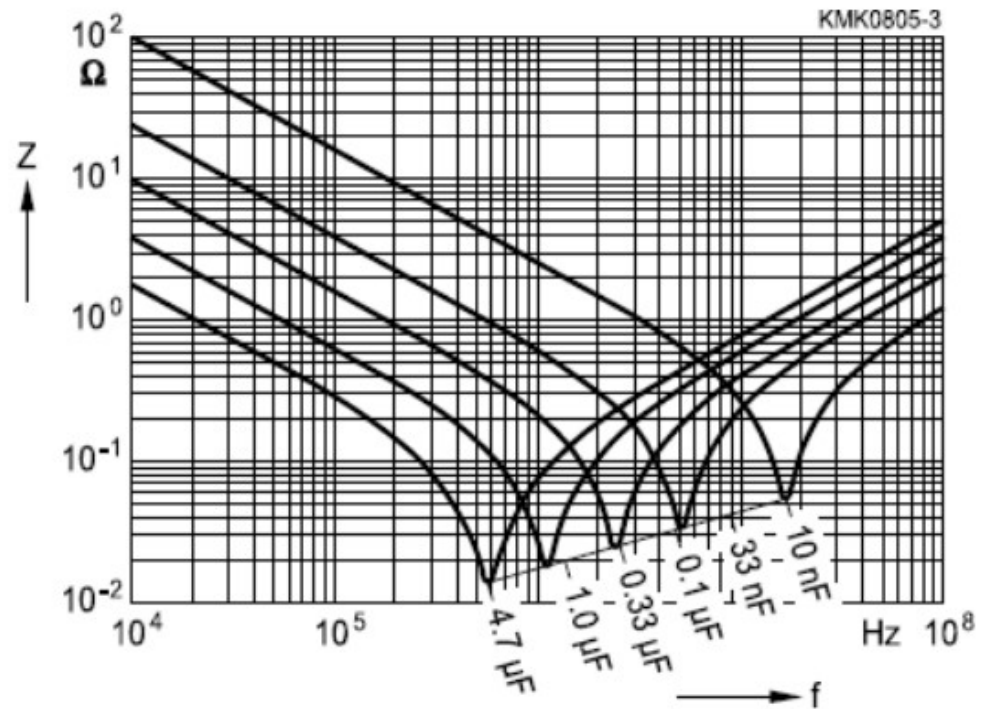

# FILM KONDENZATORI

VRSTA FILMA	OPSEG KAPACITIVNOSTI	RADNI NAPON	VREMENSKA KONSTANTA	TEMPERATURNI KOEFICIJENT
POLIESTER	100pF ÷ 100μF	50V ÷ 12500V	25000s	+600 ppm/°C
POLIPROPILEN	100pF ÷ 10μF	160V ÷ 3000V	100000s	- 250 ppm/°C
POLIKARBONAT	100pF ÷ 10μF	63V ÷ 400V	25000s	-100 ÷ 100 ppm/°C

# KERAMIČKI KONDENZATORI

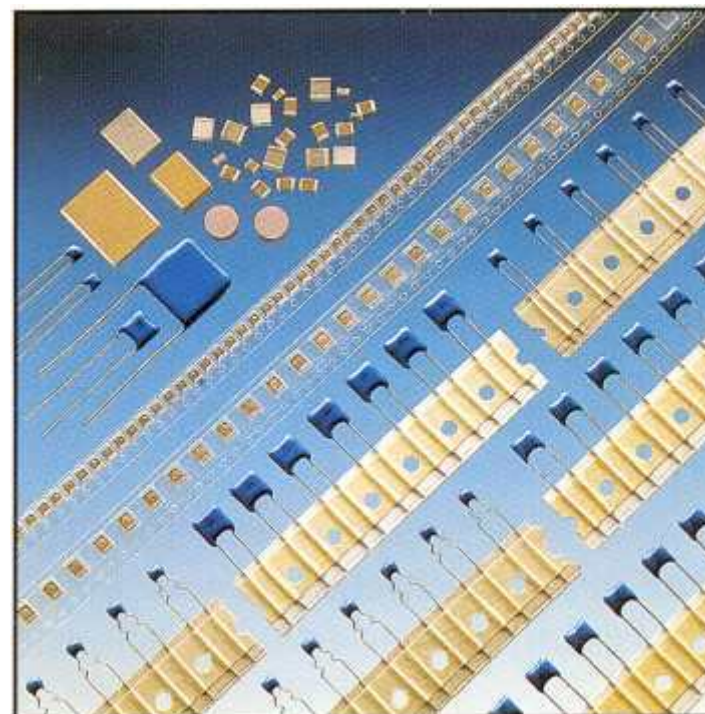
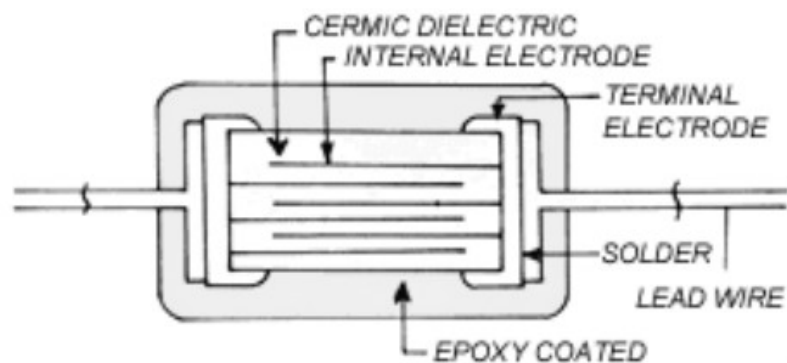

VRSTA KERAMIKE	OPSEG KAPACITIVNOSTI	RADNI NAPON	VREMENSKA KONSTANTA	TEMPERATURNI KOEFICIJENT
COG (NPO)	1pF ÷ 100nF	50V ÷ 200V	1000s	-30 ÷ 30 ppm/°C
X7R	470pF ÷ 4,7μF	50V ÷ 200V	1000s	-0,1 ÷ 0,1 %/°C
Z5U	10nF ÷ 4,7μF	50V ÷ 100V	500s	-1 ÷ 1 %/°C

## Tantal (polarizovani)

OPSEG KAPACITIVNOSTI	TOLERANCIJA	RADNI NAPON	STRUJA CURENJA
0,1 $\mu$ F ÷ 1000 $\mu$ F	-20% ÷ +20%	2,5V ÷ 50V	$\leq 0,01\mu\text{A} \cdot \left(\frac{C}{\mu\text{F}} \cdot \frac{U}{\text{V}}\right)^{0,7}$ ( $> 0,5\mu\text{A}$ )

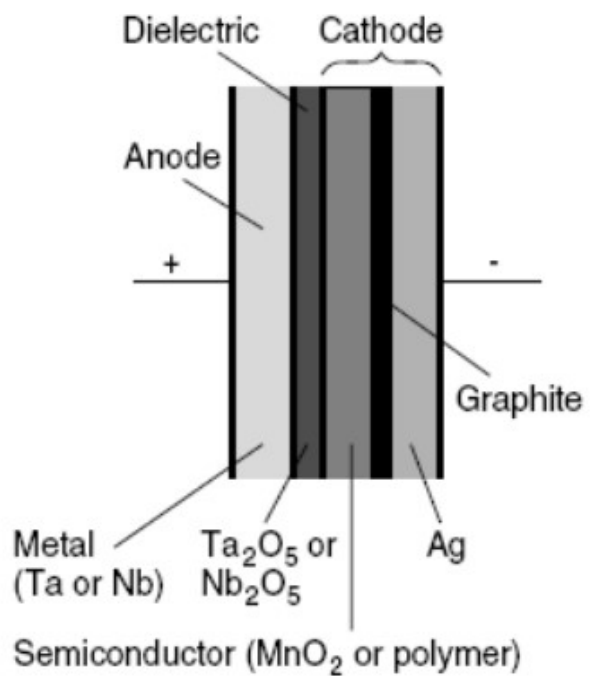

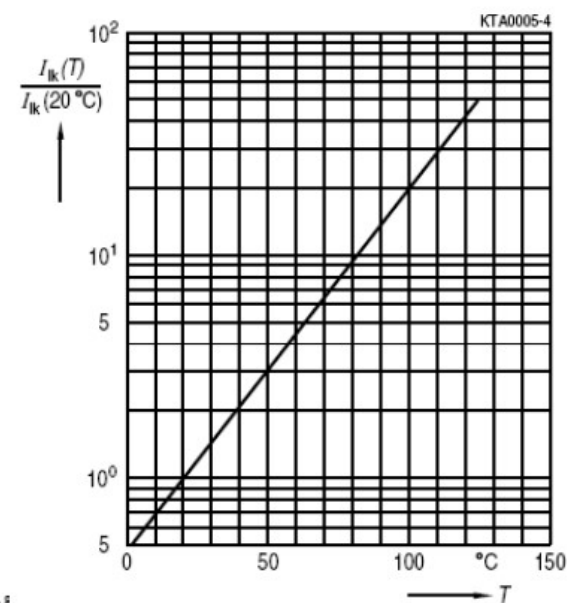
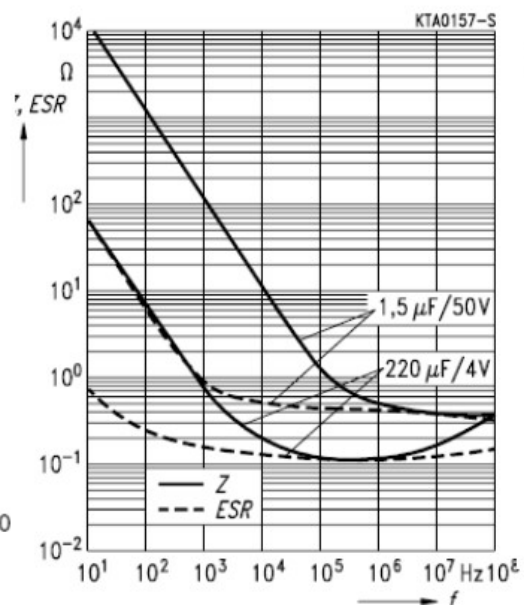
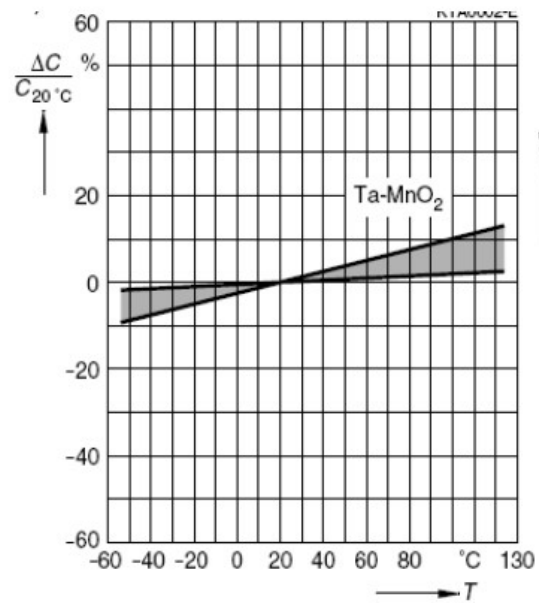

- Polarizovani
  - Tantal  $C \leq \sim 1000 \mu\text{F}$
- Nepolarizovani
  - Z5U
  - X7R
  - NPO
  - Polikarbonat MKC,FKC
  - Poliester FKS,MKS
  - Polipropilen FKP,MKP
  - Polystyrene

High-Performance Solutions

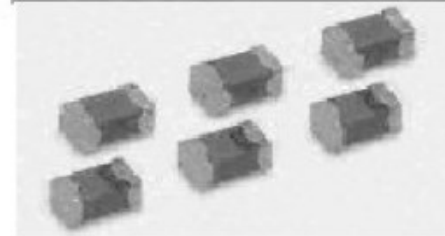
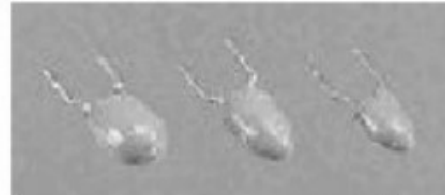

High-Performance Solutions

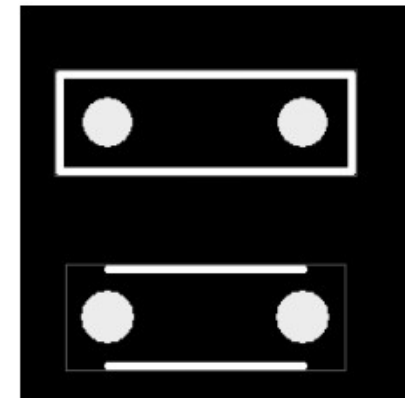
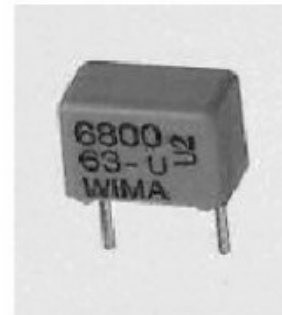
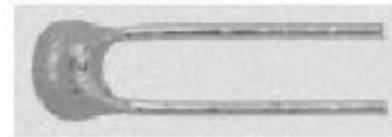



# ELEKTROLITSKI KONDENZATORI

## Aluminijumski (polarizovani i bipolarni)

OPSEG KAPACITIVNOSTI	TOLERANCIJA	RADNI NAPON	STRUJA CURENJA
0,1 $\mu$ F ÷ 10000 $\mu$ F	-20% ÷ +20%	6,3V ÷ 450V	$\leq 0,3\mu\text{A} \cdot \left(\frac{C}{\mu\text{F}} \cdot \frac{U}{\text{V}}\right)^{0,7} + 4\mu\text{A}$

### Polarizovani:

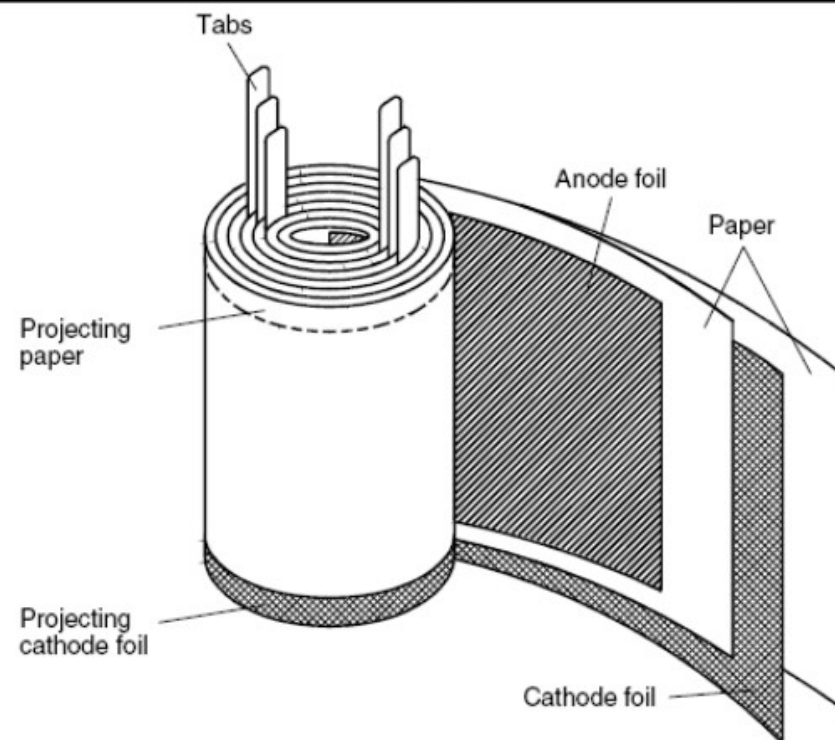
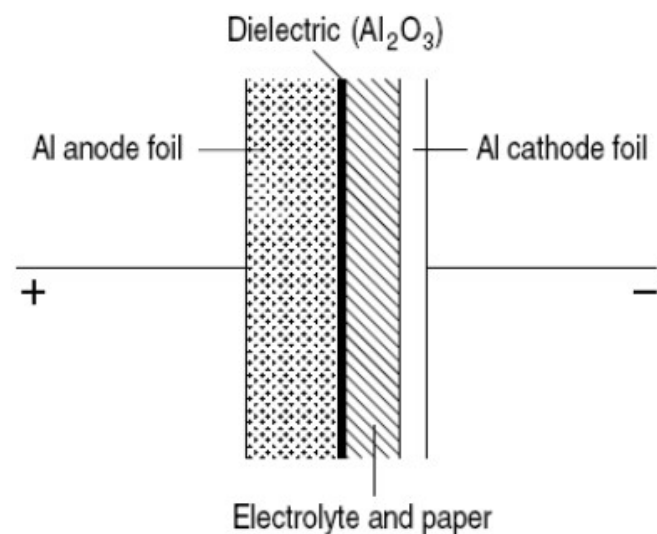

- aksijalni
- Radijalni
- Bipolarni/unipolarni
- Long-life/standardni
- Karakteristike:

napon  
 RMS struje  
 kapacitet  
 life span

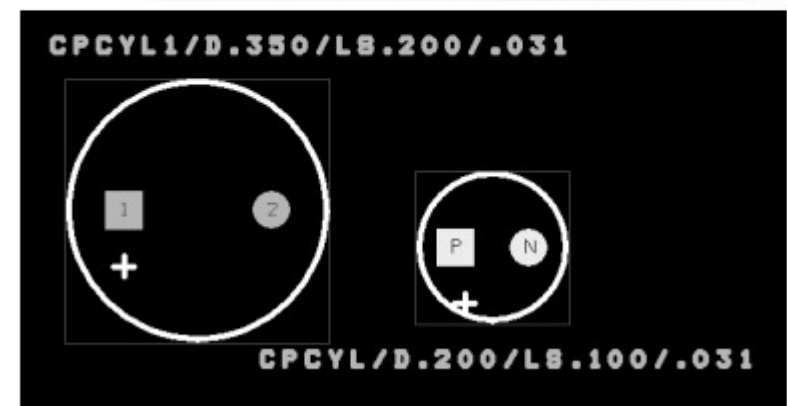
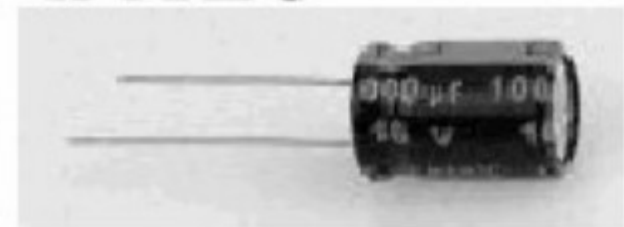
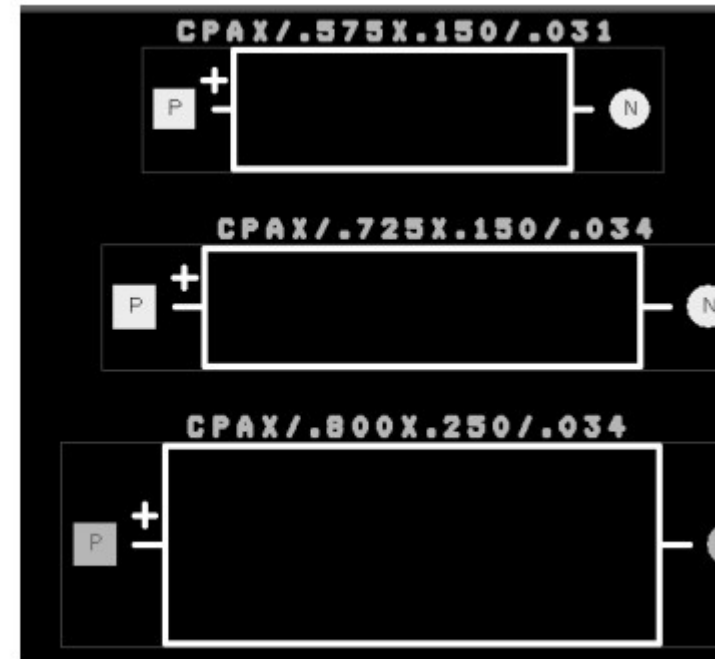
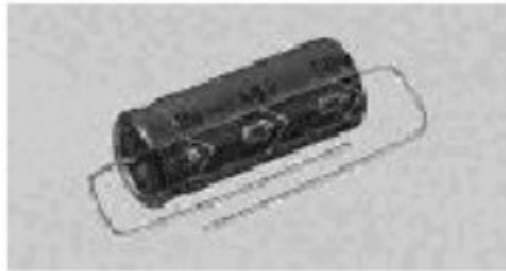

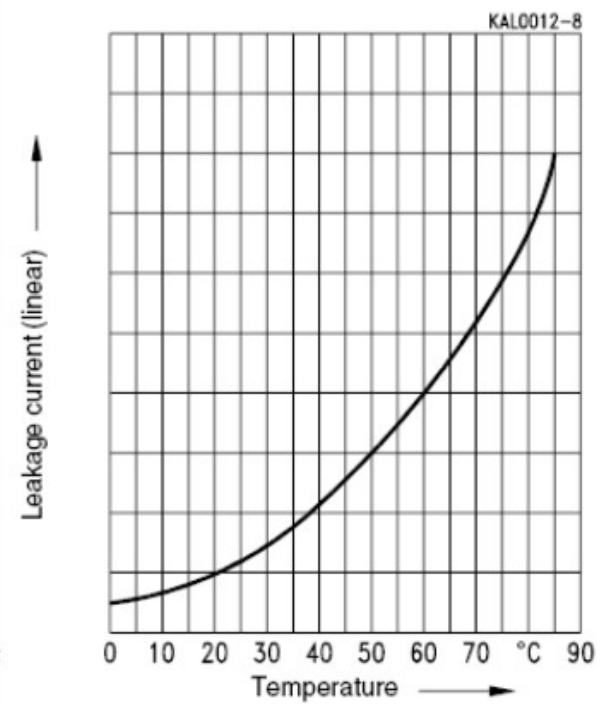
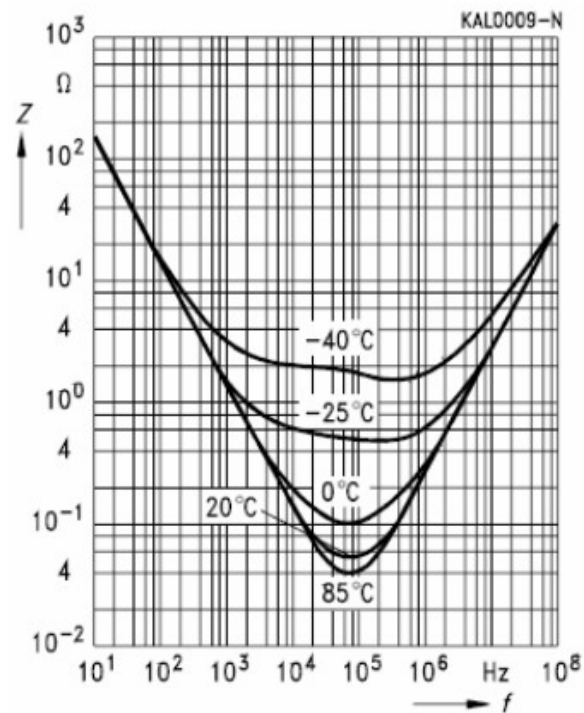
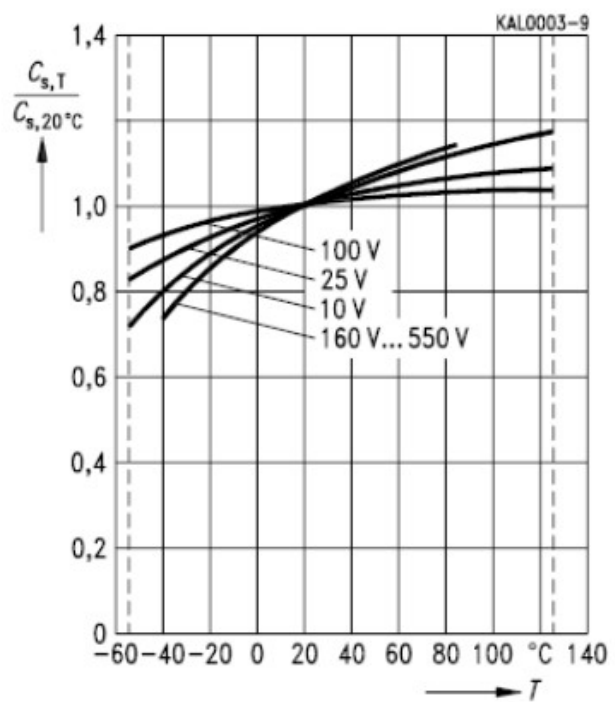

- Aluminijumski-tečni elektrolit
  - Jeftini, nepouzdati na visokom temperaturama, veliko ESR, veliki kapacitet, veliki naponi
- Hibridni elektrolit, gel
  - 2-3 puta skuplji, malo ESR, temperaturno stabilni, retko se proizvode za velike napone, OS-CON
- Solid elektrolit
  - Najbolji, ali i najskuplji

## Dvoslojni elektrohemijski (polarizovani i nepolarizovani)

OPSEG KAPACITIVNOSTI	TOLERANCIJA	RADNI NAPON
0,047 F ÷ 5000 F	-10% ÷ +30%	2,3V ÷ 2,5V

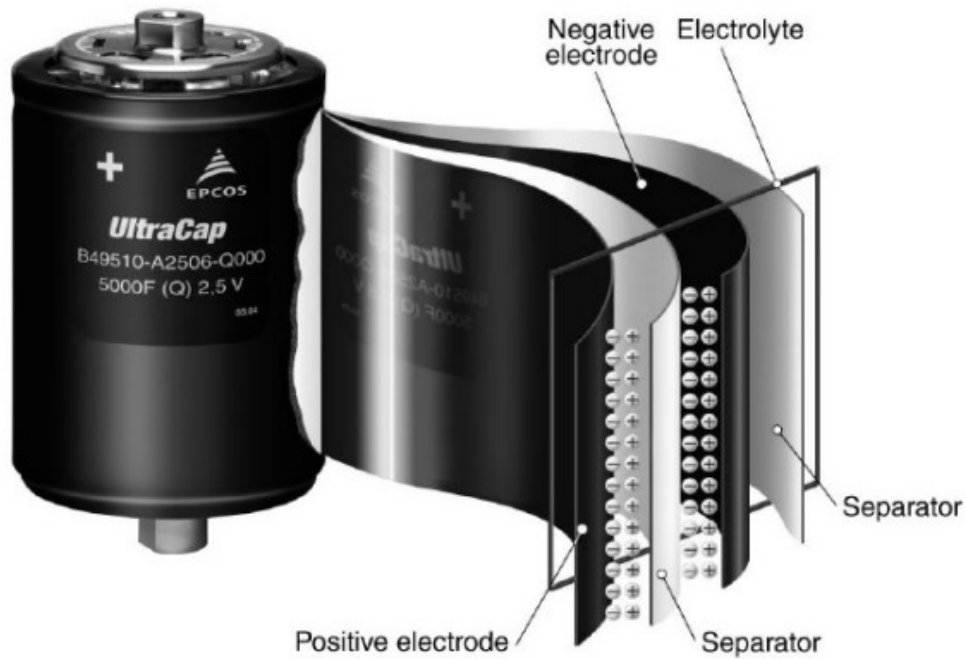



**Primene:**

**Mrežne prigušnice, prigušnice za signalne linije, VHF prigušnice, RF prigušnice**



**Induktivnosti: za ISDN/xDSL, za DC/DC konvertore, za RF**

**EMC filtri**

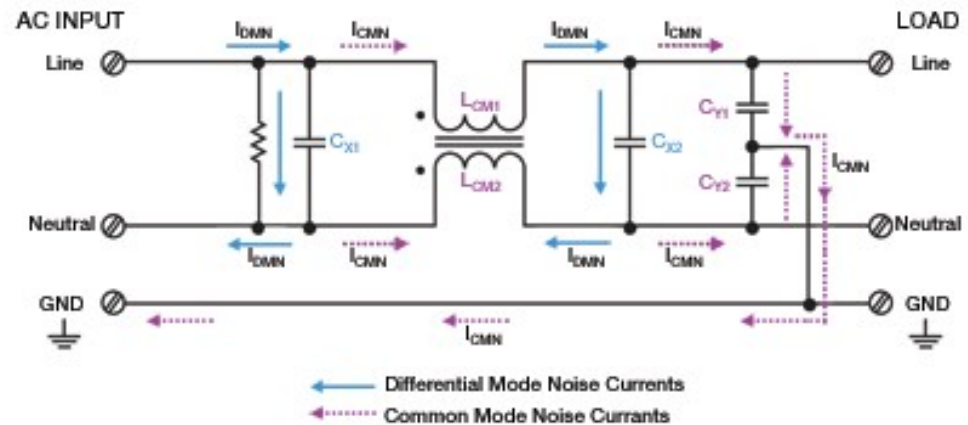

# AKTIVNE KOMPONENTE

Ne postoje jedinstveni standardi za označavanje aktivnih komponenata.

USA: Joint Electron Device Engineering Council (JEDEC)

Japan: Japanese Industrial Standard (JIS)

Evropa: Pro-Electron

## **JEDEC:**

Forma: cifra, slovo, redni broj, [sufiks]

Cifra je 1 za diode, 2 za tranzistore, 3 za elemente sa četiri priključka itd. Cifre 4 i 5 su rezervisane za optokaplere.

Slovo je uvek N

Redni brojevi idu od 100 do 9999 i ukazuju na približno vreme kada je komponenta napravljena.

Sufiks je neobavezan i ima različita značenja: klasu pojačanja, učestanosti, napona itd.



## **JIS:**

Forma: cifra, dva slova, redni broj, [sufiks]

Cifra je 1 za diode, 2 za tranzistore itd.

Slova ukazuju na tip i namenu komponente prema sledećem kodu:

SA:PNP HF tranzistor

SB:PNP AF tranzistor

SC:NPN HF tranzistor

SD:NPN AF tranzistor

SE:Dioda

SF:Tiristor

SG:Gunn dioda

SH:UJT

SJ:P-kanalni FET

SK:N-kanalni FET

SM:Triak

SQ:LED

SR:Usmerač

SS:Signalna dioda

ST:Lavinska dioda

SV:Varikap dioda

SZ:Zener dioda

## Pro-Electron

Forma: dva slova, [slovo], redni broj, [sufiks]

Prvo slovo označava materijal:

A = Ge

B = Si

C = GaAs

R = kombinovani materijali.

Drugo slovo ukazuje na tip i namenu komponente:

A: dioda, RF

B: dioda, varactor

C: tranzistor, AF, mali signali

D: tranzistor, AF, snažni

E: Tunnel diode

F: tranzistor, HF, mali signali

K: Hall effect senzor

L: Tranzistor, HF, snažni

N: Optokapler

P: Detektor zračenja

Q: Izvor zračenja

R: Tiristor, male snage

T: Tiristor, snažni

U: Tranzistor, snažni, prekidački

Y: Usmerač

Z: Zener dioda, dioda za regulaciju napona

Treće slovo ukazuje na industrijsku ili komercijalnu primenu.

Kod integrisanih kola najviše su standardizovane familije digitalnih kola – osnovne i usavršene TTL familije i njima kompatibilne CMOS familije. Oznake komponenata počinju prefiksom koji govori o familiji, iza kojeg sledi broj kojim se označava određeni tip kola u familiji.

### **Klasifikacija digitalnih integrisanih kola:**

<b>Složenost</b>	<b>Broj logičkih kola</b>
Small-scale integration (SSI)	Manje od 12
Medium-scale integration (MSI)	12 to 99
Large-scale integration (LSI)	100 to 9999
Very large-scale integration (VLSI)	10,000 to 99,999
Ultra large-scale integration (ULSI)	100,000 ili više

## Označavanje familija logičkih kola

Prefiksi za integrisana kola

<b>TTL Series</b>	<b>Prefix</b>	<b>CMOS Series</b>	<b>Prefix</b>
Standard TTL	74	Metal-gate CMOS	40 or 140
High-Speed TTL	74H	Metal-gate CMOS	40 or 140
Low-Power TTL	74L	Metal-gate, pin-compatible with TTL	74C
Schottky TTL	74S	Silicon-gate , pin-compatible with TTL, high-speed	74HC
Low-power Schottky TTL	74LS	Si gate, high-speed, electrically compatible with TTL	74HCT
Advanced Schottky TTL	74AS	...	...
Advanced low-power Schottky TTL	74ALS	...	...

**MELF**

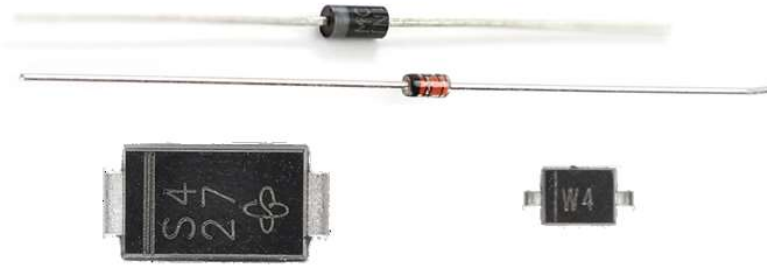

**DO XY**

**TO 18**

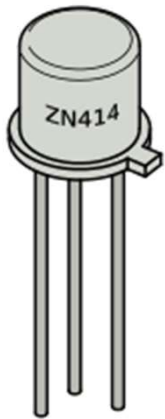

**TO 39**



**TO 92**

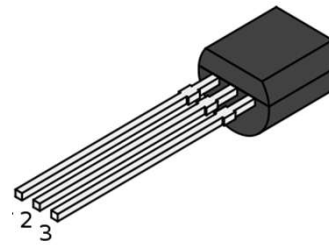

**TO 126**

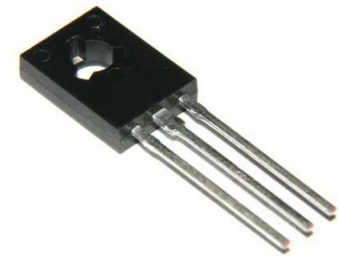

**SOT 223**



**SOT 23**

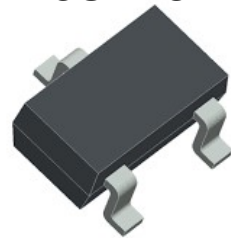

**SOT 89**

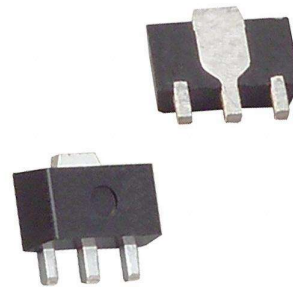

**TO 220**

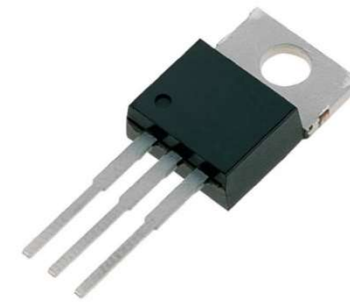

Označavanje ostalih integrisanih kola uglavnom nije standardizovano, već sami proizvođači dodeljuju oznake tipa prema svojim internim klasifikacijama. Kada se radi o komponentama koje proizvodi veći broj proizvođača, oznake su ili različite ili slične oznaci proizvođača koji je komponentu prvi proizveo. Kada su oznake slične, obično je redni broj u oznaci isti, a prefiks i sufiks su različiti.

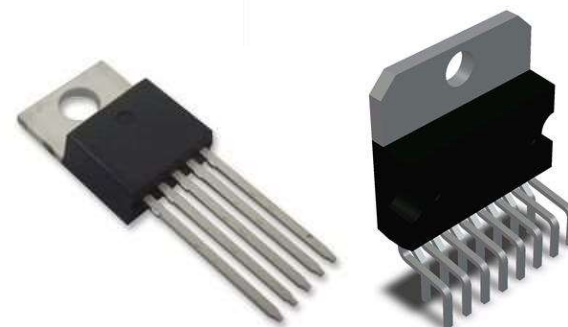
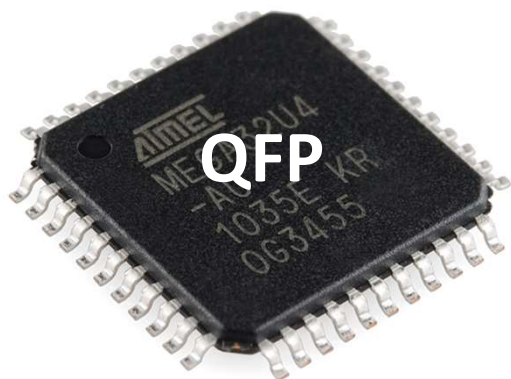
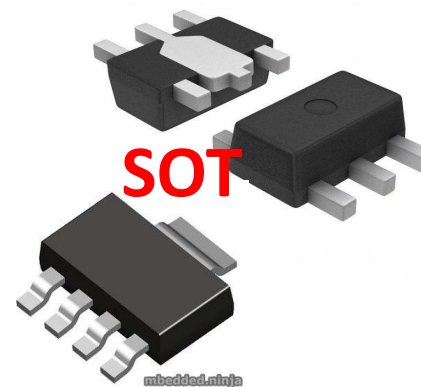
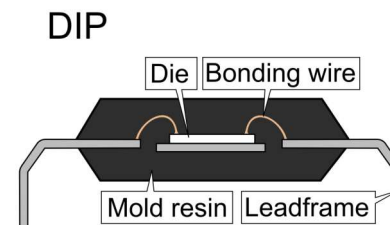
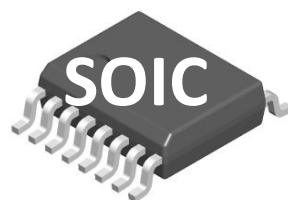
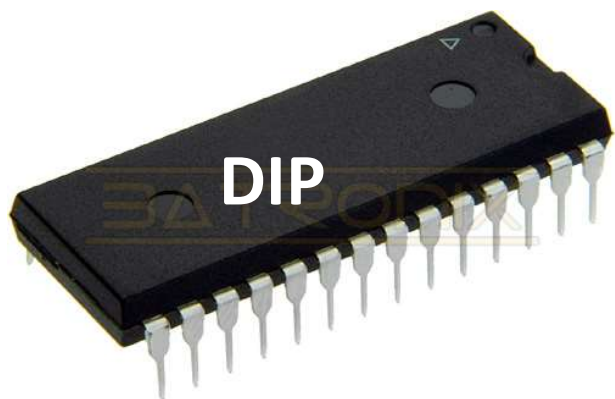

- Fiksni stabilizatorji

- Pozitivni

- 7805,7809,7812...

- Negativni

- 7905,7909,7912...

- Podesivi

- pozitivni:LM317

- Negativni:LM337

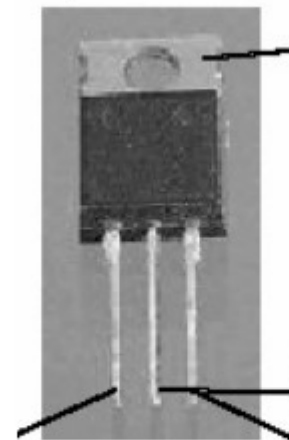

TO-92

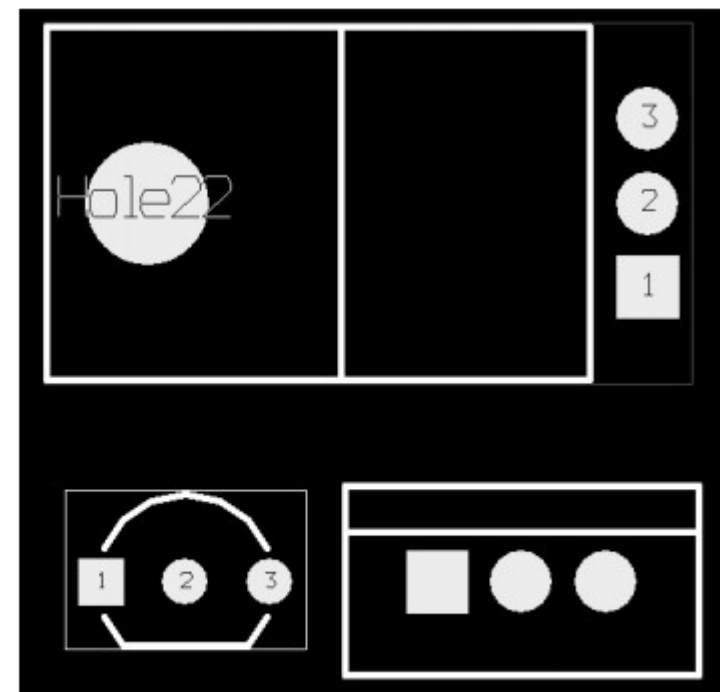

# Hladnjaci

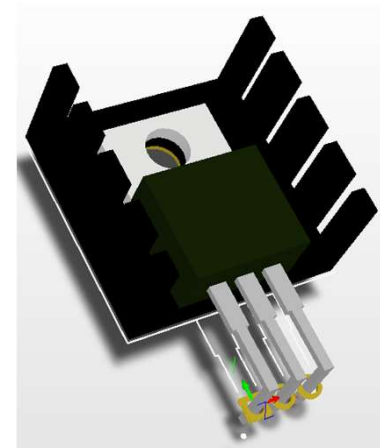
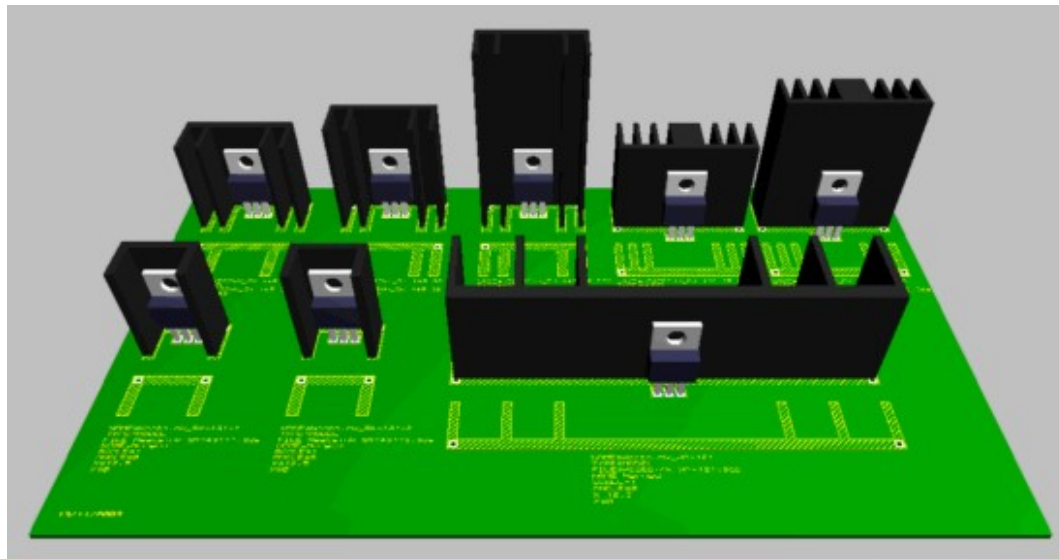



# GRECOVI SPOJEVI

SMT Min Single Phase -  
MBS Bridge Rectifiers

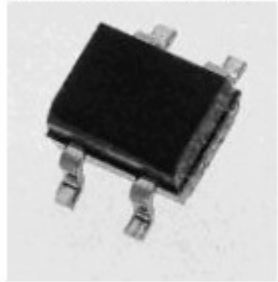

SMT Single Phase - DFS  
Bridge Rectifiers

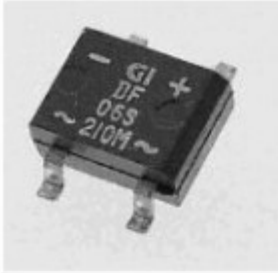

Bridge Rectifier Single  
Phase - DFS Series,  
SMT **NEW**

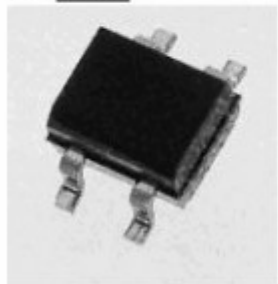

1A DIL, Bridge  
Rectifiers-DF0

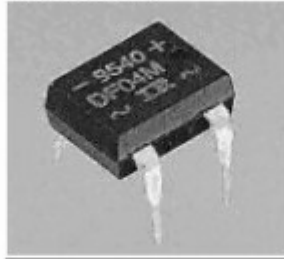

1-2A

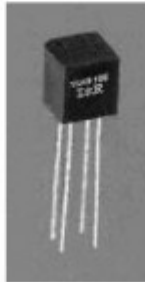

1-2A Single Phase

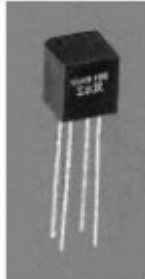

1-5A Bridge Rectifiers

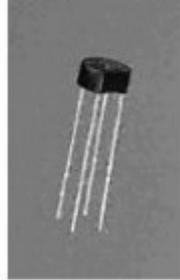

1.7A In-Line Bridge  
Rectifiers



1.9A Single Phase  
Bridge Rectifier

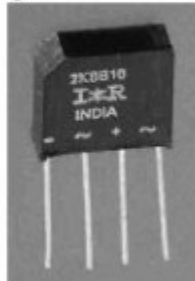

2A In-Line Rectifiers

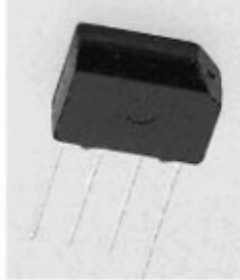

Bridge Rectifier 2A  
Single Phase **NEW**

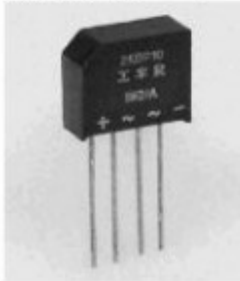

2-7A In-Line Rectifiers



Bridge Rectifier 3A  
Single Phase **NEW**

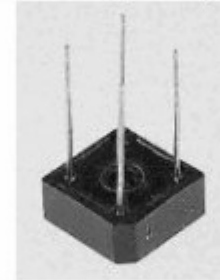

4A In-Line Bridge  
Rectifiers



6A In-Line, Bridge  
Rectifiers

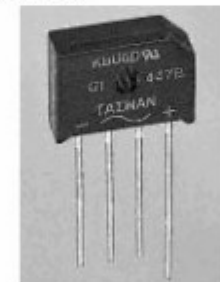

8A, In-Line, Bridge  
Rectifiers

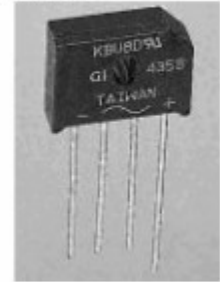

Square Moulded Bridge  
Rectifiers

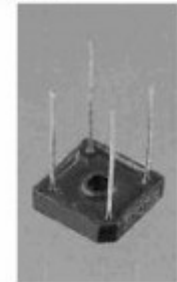

6A Single Phase, Bridge  
Rectifiers

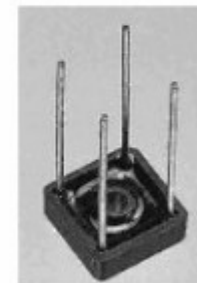

# KONEKTORI

PCB Transistor Holder



T03/T066 Sockets

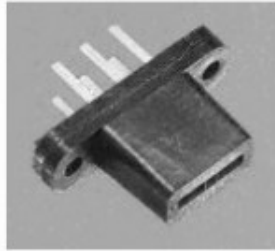

tyco Electronics Augat Tin Plate DIL Sockets

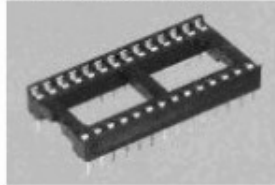

Low Profile Tin Plated 6 to 48-way

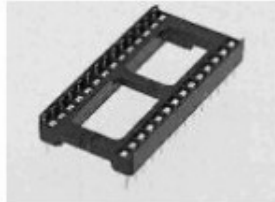

Standard, Gold Plate, DIL Sockets

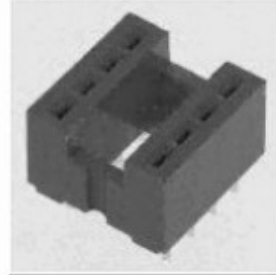

Low Profile, Gold Plate, DIL Sockets

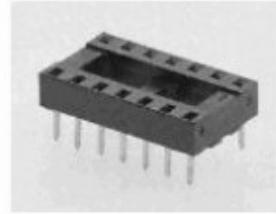

Low Profile, Formed Pin, DIL Sockets

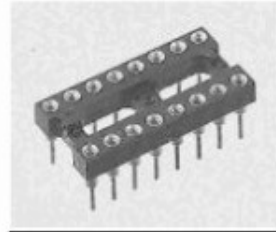

Turned Pin, DIL Sockets

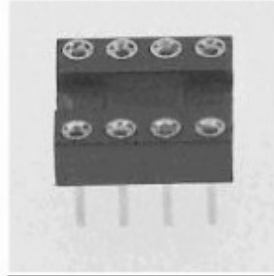

Ultra Low Profile Gold-Plated Contact DIL Sockets

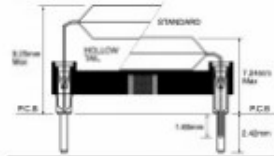

DIP Sockets with Decoupling Capacitor

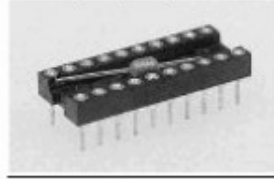

SMT DIL Sockets



Turned Pin, Wire Wrapping, DIL Sockets

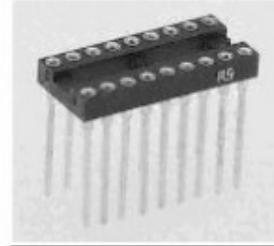

Shrink DIP Sockets



Breakable Shrink DIP

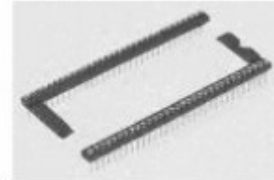

Professional IC Test Clips



Vertical Mount, DIL Sockets

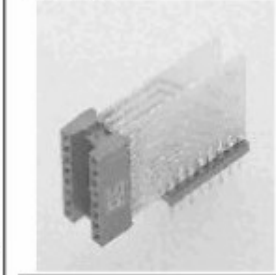

DIL Signal Isolators

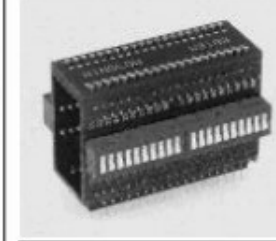

Slotted Header

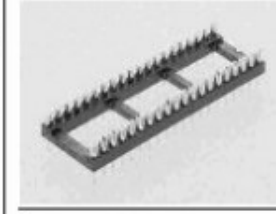

Through Headers



Low Profile DIL Eject Sockets

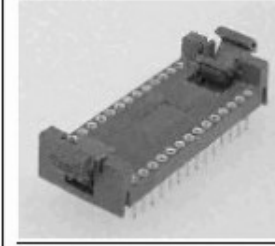

3M Std ZIF DIP Sockets

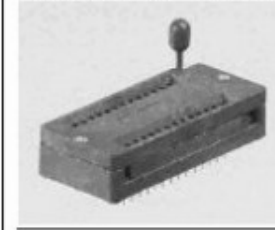

3M Universal ZIF DIP Sockets

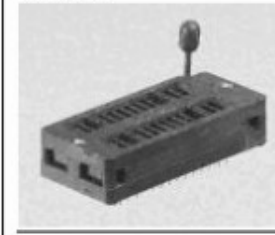

3M Shrink Zif DIP Sockets

- tasteri, prekidači (NO, NC; momentary/latched)

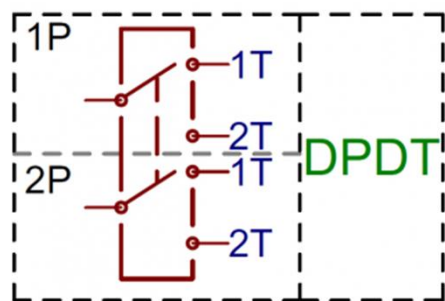
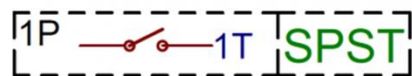

!XPYT moguće!

# Relay

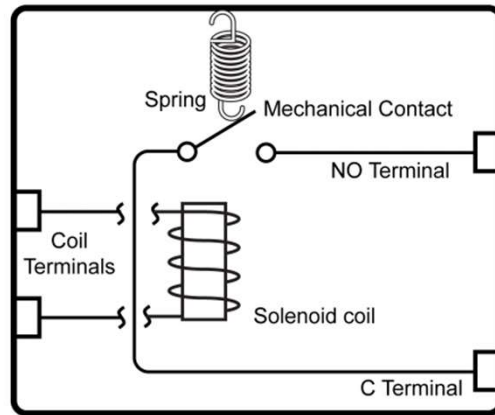

Physical

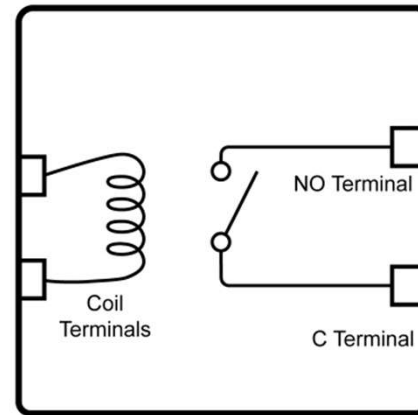

Electrical

